

SECURITY



To comply with Building Regulations, windows and doors must be sufficiently robust and fitted with appropriate hardware in order to be able to resist physical attack by a casual or opportunist burglar.

Approved Document Q: security, dwellings – covers the standards for doors and windows to resist physical attack by a burglar. It includes standards on being both sufficiently robust and fitted with appropriate hardware. This also supports requirement Q1 of schedule 1 to the Building Regulations 2010. Requirement Q1 applies only in relation to new dwellings and provides that reasonable provision must be made to resist unauthorised access to any dwelling; and any part of a building from which access can be gained to a flat within the building.

Performance can be demonstrated by evidencing that the product is manufactured to a design that has been shown by test to meet the security requirements of British Standard PAS 24:2016.

PAS 24:2016 provides a method of testing and assessing the enhanced security performance requirements of doors and window types intended to resist the levels and methods of attack experienced in the UK and normally associated with the casual burglar.

All principle Westcoast composite windows and doors have not only been successfully tested to PAS 24:2016 but Westcoast are also a Secured by Design licence holder, an award that requires member companies to regularly undertake re-testing and auditing through independent UKAS accredited 3rd Party certification schemes to ensure consistency of product quality and performance.

Westcoast Windows approved window & doors:

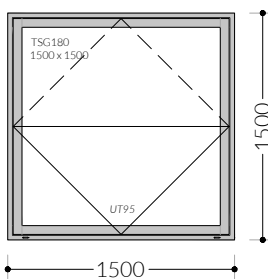

Top Hung Reversible
(outward opening)

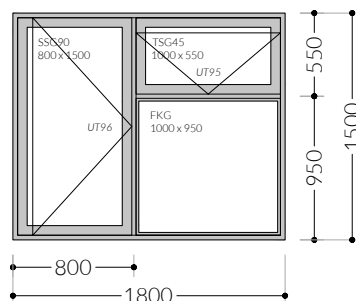

Multi-light Window
(outward opening)

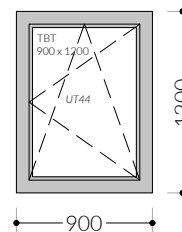

Tilt before Turn
(inward opening)

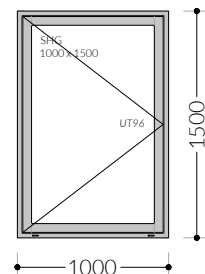

Side Hung*
(outward opening)

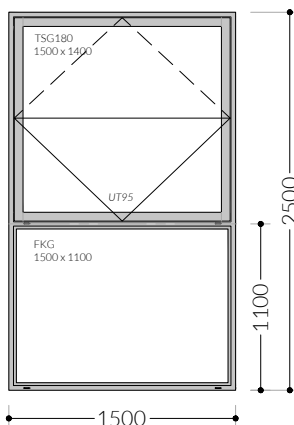

Combination Window
(outward opening)

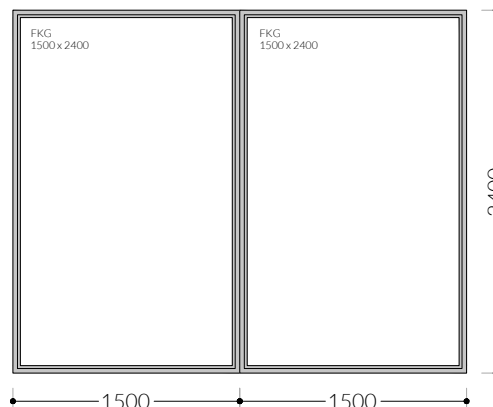

Coupled Fixed Light*
(outward opening)

CONTINUED OVERLEAF..

SECURITY



Westcoast Windows approved window & doors:

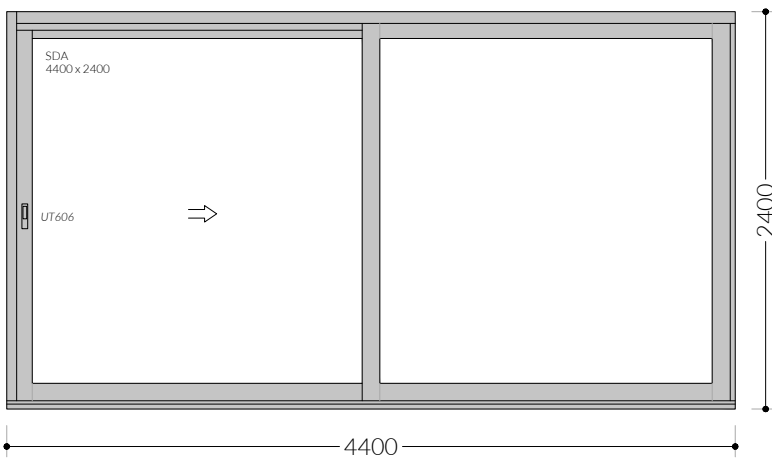
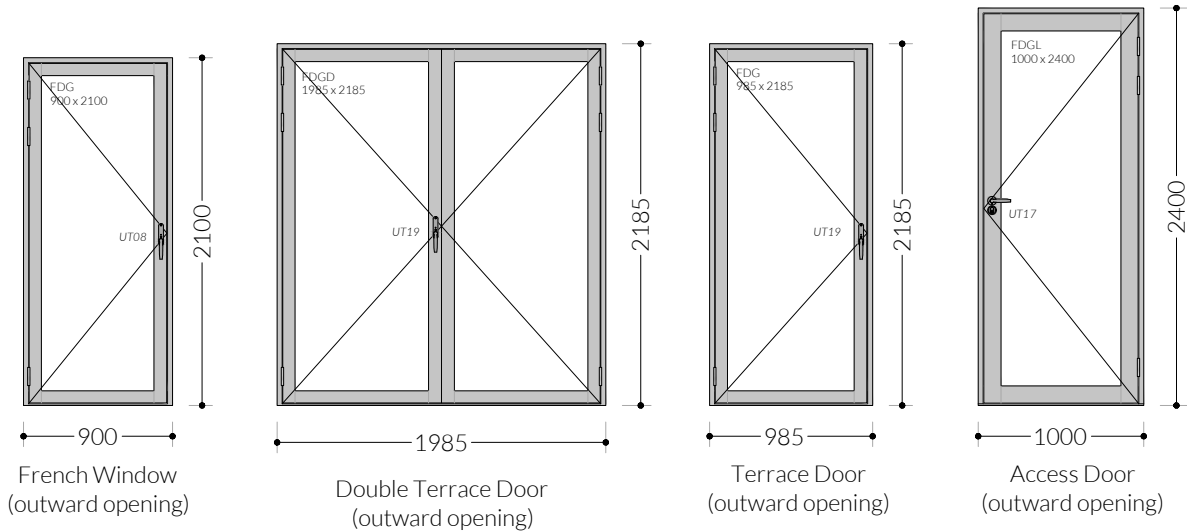

Lift & Slide Door

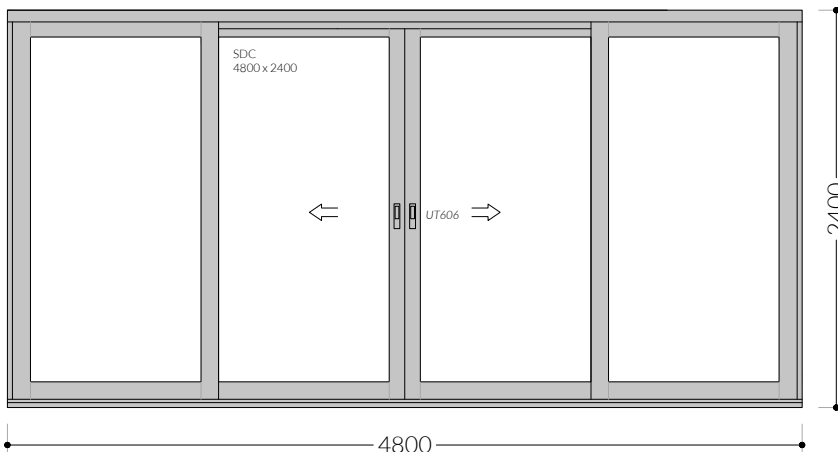

Lift & Slide Door - Bi-Parting